

GELUID-GEDEMPTE BOXVENTILATOREN
CVAB/T-N ECOWATT Series



Geluid-gedempte boxventilator van gegalvaniseerde plaatstalen panelen. Inwendig geïsoleerd met M0 onbrandbare thermische en geluiddempende isolatie met een dikte van 25 mm. De panelen zijn luchtdicht gevat in een aluminium frame met kunststof hoekprofielen. Direct gedreven borstelloze EC motor, hoog rendement, laag opgenomen vermogen, kogellagers, ingebouwde thermische beveiliging en geschikt voor werktemperaturen -20°C tot +40°C.

- 1-fase uitvoering 230V±10% 50/60Hz, IP44
- 3-fasen uitvoering 400V±10% 50/60Hz, IP54.

De CVAB ECOWATT is energiezuinig en geschikt voor zowel binnen- als buitenopstelling (door toevoeging van een optioneel regenbeschermdak).

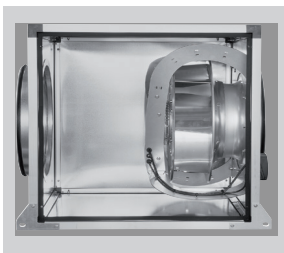

Waaier met achterover gebogen schoepen
om vervuiling te voorkomen, dynamisch gebalanceerd.

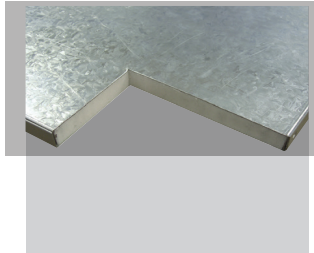

Geluiddempende isolatie
25 mm, M0 thermisch en geluid-dempend.



Solide constructie
Hoogwaardig behandeld aluminium profielen, met kunststof hoekdelen, zorgen voor een solide constructie.



IP55 aansluitdoos
Voor voeding, en inwendige potmeter voor toerenregeling.

Flexibiliteit in luchtzijdige aansluitingen

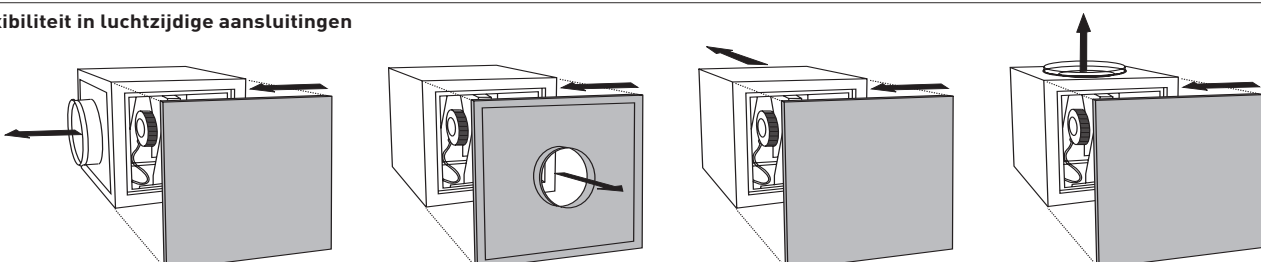

GELUID-GEDEMPTE BOXVENTILATOREN
CVAB/T-N ECOWATT Series

TECHNISCHE GEGEVENS

Controleer voor de montage of elektrische voeding klopt met de aansluiting.

1 FASE 230V±10% 50/60HZ

Model	Stuurstroom	Toeren (r.p.m.)	Max. Opgenomen vermogen (W)	Max. Opgenomen stroom (A)	Max. Debiet (m³/h)	Geluidsdruk (dB(A)) op 1,5 m*			Gewicht (kg)
						Inlaat	Uitlaat	Afgestraald	
CVAB-1400/250N ECOWATT	10	2650	200	1,3	1.318	59	63	47	25
	8	2273	129	0,9	1.126	56	60	44	
	6	1787	67	0,5	866	51	55	39	
	4	1270	29	0,3	638	43	47	31	
CVAB-2000/315N ECOWATT	10	1899	210	0,9	2.103	56	61	49	26
	8	1671	148	0,7	1.861	53	58	46	
	6	1336	81	0,4	1.471	48	53	41	
CVAB-3000/355N ECOWATT	4	1019	42	0,3	1.096	42	47	35	41
	10	1799	347	1,4	3.049	61	65	50	
	8	1592	251	1,1	2.728	58	62	47	
CVAB-4000/400N ECOWATT	6	1277	131	0,6	2.212	53	57	42	42
	4	973	64	0,3	1.679	47	51	37	
	10	1644	497	2,1	4.116	61	63	52	
CVAB-6000/450 N ECOWATT	8	1516	394	1,6	3.645	59	61	50	49
	6	1233	216	0,9	2.964	54	56	46	
	4	944	102	0,5	2.301	48	51	40	
CVAB-6000/450 N ECOWATT	10	1459	1021	4,17	6.391	64	65	55	49
	8	1285	711	2,94	5.061	62	63	51	
	6	1060	407	1,68	4.594	58	58	48	
	4	833	208	0,87	3.595	53	53	42	

* Middelpunt van de curve.

3 FASE 400V±10% 50/60HZ

Model	Stuurstroom	Toeren (r.p.m.)	Max. Opgenomen vermogen (W)	Max. Opgenomen stroom (A)	Max. Debiet (m³/h)	Geluidsdruk (dB(A)) a 1,5 m*			Gewicht (kg)
						Inlaat	Uitlaat	Afgestraald	
CVAT-9000/500 N ECOWATT	10	1370	1235	2,1	7620	63	63	51	61
	8	1220	878	1,5	6700	61	61	48	
	6	1010	508	0,9	5510	57	56	44	
	4	800	274	0,6	4440	52	52	39	
CVAT-12000/560 N ECOWATT	10	1380	2653	3,9	11830	68	69	53	85
	8	1150	1555	2,4	9710	64	65	49	
	6	920	809	1,4	7690	59	60	44	
	4	680	361	0,7	5740	53	54	37	

* Middelpunt van de curve.

GELUID-GEDEMPTE BOXVENTILATOREN
CVAB/T-N ECOWATT Series



AFMETINGEN (mm)

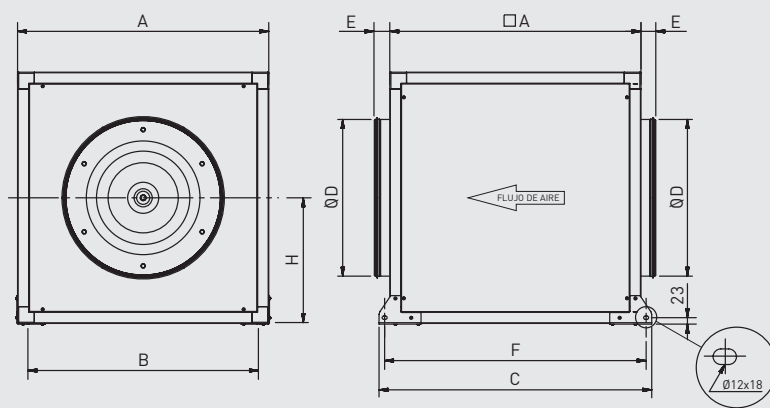

Model CVAB-N ECOWATT	A	B	C	D	E	F	H
1400/250 N	500	457	574	250	58	534	250
2000/315 N	500	457	574	315	58	534	250
3000/355 N	650	607	724	355	58	684	325
4000/400 N	650	607	724	400	58	684	325
6000/450 N	750	707	824	450	58	784	375
9000/500 N	800	757	874	500	58	834	400
12000/560 N	900	826	977	560	58	937	450

GELUID-GEDEMPTE BOXVENTILATOREN
CVAB/T-N ECOWATT Series

PRESTATIES EN AKOESTISCHE KARAKTERISTIEKEN

- q_v : Luchthoeveelheid in m^3/h .
- p_{st} : Statische druk in Pa.
- P: Ingangsvormogen in W.
- SFP: Specifiek ventilatorvermogen in $W/m^3/s$ (blauwe curves).
- Gegevens over prestatievermogen in overeenstemming met ISO 5801 en AMCA 210-99 normen.

CVAT-12000/560 N ECOWATT

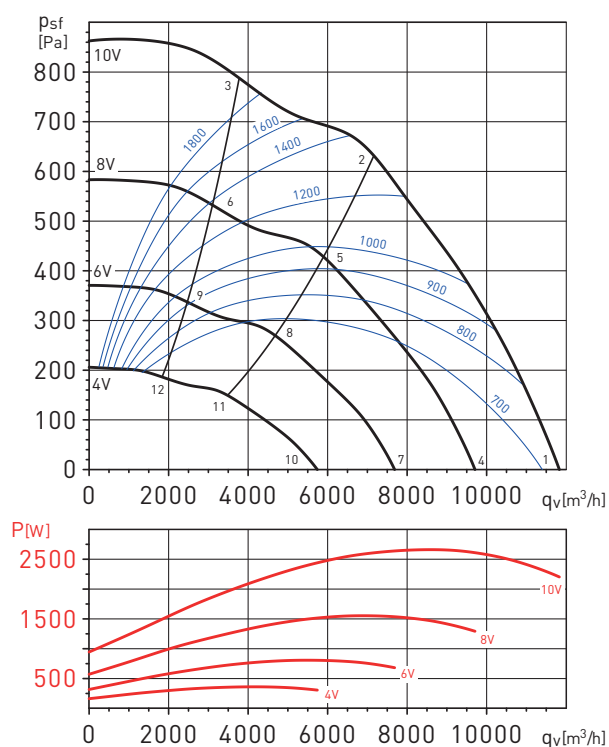
Geluidsvermogen per frequentie in dB(A)

Werkpunt		63	125	250	500	1.000	2.000	4.000	8.000	LwA
1	Inlaat	61	75	78	81	80	79	77	71	87
	Uitlaat	62	68	72	80	84	81	77	70	88
	Afgestraald	60	63	69	61	61	61	60	48	72
2	Inlaat	54	70	73	75	76	77	75	70	83
	Uitlaat	50	59	66	74	78	79	76	70	84
	Afgestraald	53	58	64	54	57	59	58	47	67
3	Inlaat	55	75	72	73	74	77	75	71	83
	Uitlaat	51	61	64	72	76	79	76	70	83
	Afgestraald	54	63	63	53	55	59	58	47	68
4	Inlaat	57	71	74	77	76	75	73	67	83
	Uitlaat	58	64	68	76	80	77	73	66	84
	Afgestraald	56	59	65	57	57	57	56	44	68
5	Inlaat	50	66	69	71	72	73	71	66	79
	Uitlaat	46	55	62	70	74	75	72	66	80
	Afgestraald	49	54	60	50	53	55	54	43	63
6	Inlaat	51	71	68	69	70	73	71	67	79
	Uitlaat	47	57	60	68	72	75	72	66	79
	Afgestraald	50	59	59	49	51	55	54	43	64
7	Inlaat	52	66	69	72	71	70	68	62	78
	Uitlaat	53	59	63	71	75	72	68	61	79
	Afgestraald	51	54	60	52	52	52	51	39	63
8	Inlaat	45	61	64	66	67	68	66	61	74
	Uitlaat	41	50	57	65	69	70	67	61	75
	Afgestraald	44	49	55	45	48	50	49	38	58
9	Inlaat	46	66	63	64	65	68	66	62	74
	Uitlaat	42	52	55	63	67	70	67	61	74
	Afgestraald	45	54	54	44	46	50	49	38	59
10	Inlaat	45	59	63	66	65	64	61	55	71
	Uitlaat	47	53	56	65	69	66	62	55	72
	Afgestraald	44	48	54	45	46	46	45	32	57
11	Inlaat	39	54	57	59	60	62	60	55	67
	Uitlaat	35	44	51	58	63	64	61	54	68
	Afgestraald	38	43	48	39	41	44	43	31	52
12	Inlaat	39	60	57	58	58	61	59	55	67
	Uitlaat	36	46	49	57	61	64	60	54	67
	Afgestraald	38	48	48	37	39	43	43	32	53

GELUID-GEDEMPTE BOXVENTILATOREN
CVAB/T-N ECOWATT Series

MONTAGEACCESSOIRES

MBE
 Elektrische
 verw warmer.

MBW
 Warmwater batterij.

MFL-G4
 Filterboxen.

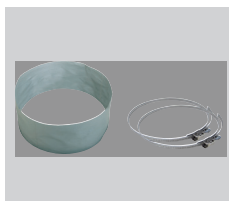
SIL
 Ronde
 geluiddemper.

ACOPEL F400 N
 Ronde flexibele
 verbinding.

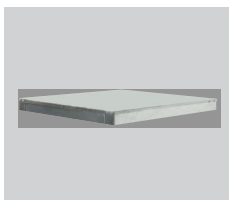
CRC
 Verloopstuk rond.

APC
 Aanzuig- / afblaas-
 kap met vogelgaas,
 bij buitenopstelling.

CTI CVA/CHAT
 Regenbeschermkap
 voor
 buitenopstelling.

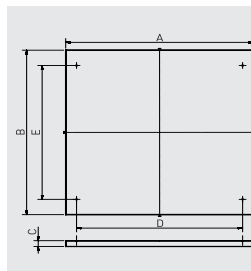
KSE
 Trilling dempers.

Modellen CVAB-N ECOWATT	Modellen APC	Modellen CTI CVA/CHAT
1400/250N	APC-250	CTI CVA-N 250/315
2000/315N	APC-315	CTI CVA-N 250/315
3000/355N	APC-355	CTI CVA-355/400 CHAT-400/450
4000/400N	APC-400	CTI CVA-355/400 CHAT-400/450
6000/450N	APC-450	CTI CVA-N 450
9000/500N	APC-500	CTI CVA-500 CHAT-500
12000/560N	APC-560	CTI CVA-N 560



Model	A	B	C	D	E
CTI CVA-N 250/315	530	530	40	419	340
CTI CVA-355/400 CHAT-400/450	680	680	40	569	490
CTI CVA-N 450	780	780	40	669	590
CTI CVA-500 CHAT-500	830	830	40	719	640
CTI CVA-N 560	930	930	40	799	720
CTI CVA-N 630	1030	1030	40	900	820
CTI CVA-N 710	1130	1130	40	1000	920
CTI CHAT-N 800	1203	1203	40	1094	994

ELEKTRISCHE ACCESSOIRES

AIRSENS-CO2/VOC/HR
 Intelligente
 luchtkwaliteits-
 sensoren voor
 vraag-gestuurd
 ventileren.

**REGELAAR
 ECOWATT AC/DC**
 Regel element voor
 vraag gestuurde
 ventilatie systemen.

**REGELAAR
 ECOWATT BASIC**
 Regelaar voor 1-fase
 aan/uit.

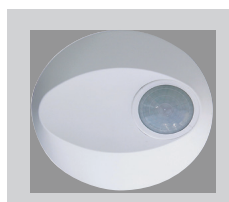
REB-ECOWATT
 Regelaar.

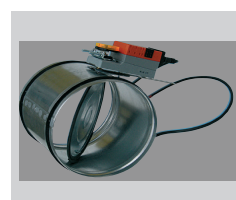
CPTA-S/CPTA-E
 Bewegings-
 sensor.

TDP-S/TDP-D/TDP-PI
 Druksensor.

REMP
 Gemotoriseerde
 open/dicht klep.