

Filterbox FLF 315

The FLF filter box is manufactured from galvanized steel sheet. It is delivered without filter.

Accessories

- FLF 315 Filter

DIMENSIONS

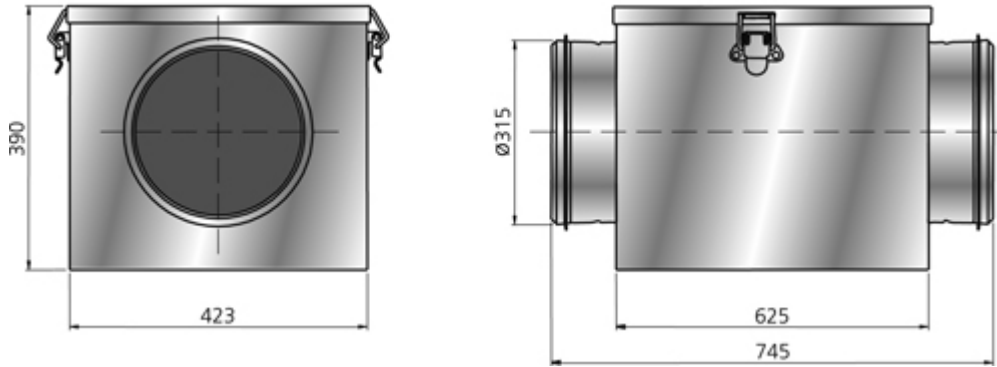

FLF 315 Filter

The FLF filters are designed for use in the FLK filter boxes. There are three different filter types to choose from classified according to EN ISO 16890.

- ePM1 (Fine): Filtration efficiencies 50–95%. Particle size up to 1 µm.
- ePM10: Filtration efficiencies 50–95%. Particle size up to 10 µm.
- Coarse: Filtration efficiencies not required. Particles all sizes.

TECHNICAL DATA	1250082 Filter FLF 315 Coarse 65%	1250083 Filter FLF 315 ePM10 60%	1250084 Filter FLF 315 ePM1 65%
Dimension	416x383x525/3 mm	416x383x525/4 mm	416x383x525/7 mm
Weight	1.01 kg	1.25 kg	1.50 kg

