



Filterbox FLF 200

The FLF filter box is manufactured from galvanized steel sheet. It is delivered without filter.

Accessories

- FLF 200 Filter

DIMENSIONS

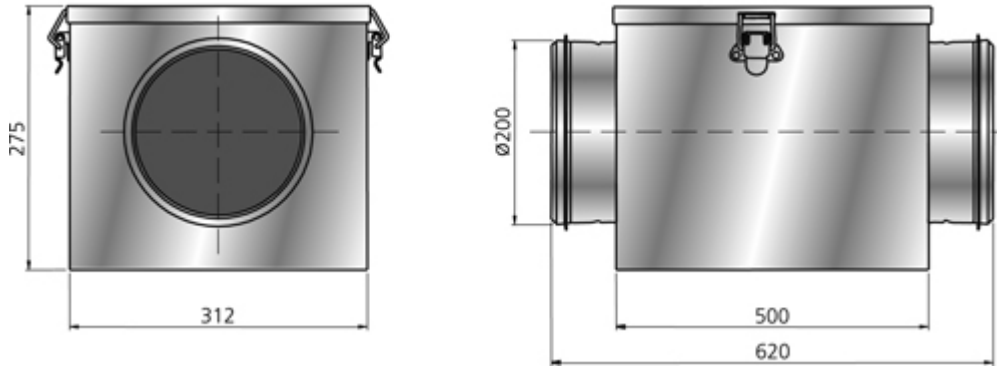

FLF 200 Filter

The FLF filters are designed for use in the FLK filter boxes. There are three different filter types to choose from classified according to EN ISO 16890.

- ePM1 (Fine): Filtration efficiencies 50–95%. Particle size up to 1 µm.
- ePM10: Filtration efficiencies 50–95%. Particle size up to 10 µm.
- Coarse: Filtration efficiencies not required. Particles all sizes.

TECHNICAL DATA	1250076 Filter FLF 200 Coarse 65%	1250077 Filter FLF 200 ePM10 60%	1250078 Filter FLF 200 ePM1 65%
Dimension	306x268x375/2 mm	306x268x375/2 mm	306x268x375/3 mm
Weight	0.60 kg	0.70 kg	0.69 kg