



Filterbox FLF 125

The FLF filter box is manufactured from galvanized steel sheet. It is delivered without filter.

Accessories

- FLF 125 Filter

DIMENSIONS

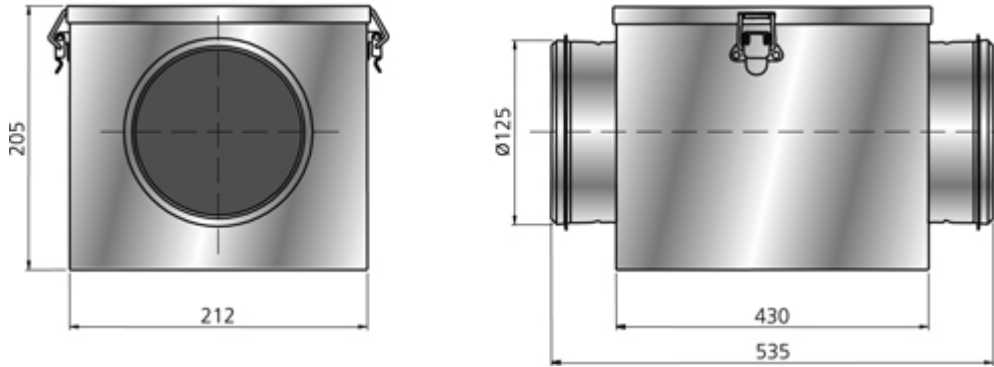

FLF 125 Filter

The FLF filters are designed for use in the FLK filter boxes. There are three different filter types to choose from classified according to EN ISO 16890.

- ePM1 (Fine): Filtration efficiencies 50–95%. Particle size up to 1 µm.
- ePM10: Filtration efficiencies 50–95%. Particle size up to 10 µm.
- Coarse: Filtration efficiencies not required. Particles all sizes.

TECHNICAL DATA	1250070 Filter FLF 125 Coarse 65%	1250071 Filter FLF 125 ePM10 60%	1250072 Filter FLF 125 ePM1 65%
Dimension	206x198x330/1 mm	206x198x330/2 mm	206x198x330/3 mm
Weight	0.30 kg	0.42 kg	0.45 kg